

ETITEC C T2 275/20 4+0



Specifications

ETI Code	002440395
Description	ETITEC C T2 275/20 4+0
Class name	Surge arrester
Function	SPD
Type	T2
Max. Discharge current I _{max} , 8/20 (kA)	40
U _c Continuous Operating Voltage (V)	275
Remote signalisation	NO
Network system	TNS
Catalogue Group	ETITEC C
I _n 8/20 (kA)	20
Number of modules	4
Up - Voltage Protection Level (kV)	<1,5
Leakage Current	YES
Applied Technology	MOV
Built-in depth (mm)	68

Online product page

Other documentation



Technical data catalogue

3D Model

Instruction manual

CE declaration

Eplan file

ETIM international classification

Classification	EC000941
Class name	Surge protection device for power supply systems
System configuration DC	
System configuration IT	
System configuration TN-C	1
System configuration TN-S	
System configuration TT	
System configuration other	
Nominal discharge surge current (8/20)	20
Nominal voltage AC	240
Short-circuit breaking capacity (I _{sc})	25
Max. continuous voltage AC	275
Max. discharge surge current (8/20)	40
Mounting method	DIN rail (top hat rail) 35 mm
Construction size	4 modular spacing
Voltage protection level	1,5
Max. conductor cross section solid (solid, stranded)	35
Max. conductor cross section flexible (fine-strand)	25
With remote signalling contact	
Integrated backup fuse	
Signalling at the device	Optical
Category type 2	1
Degree of protection (IP)	IP20

Dimension drawing

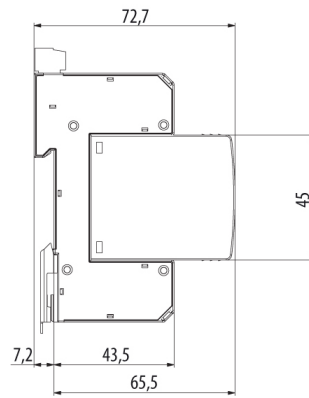
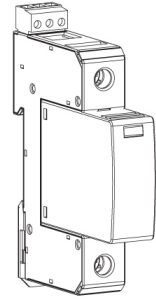
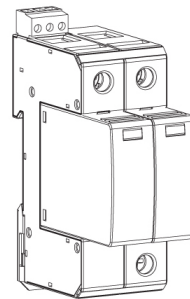
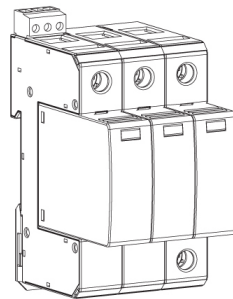
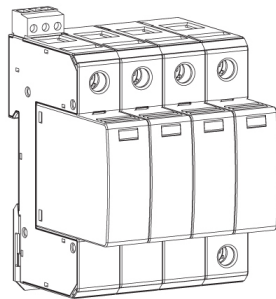
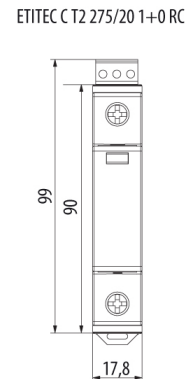
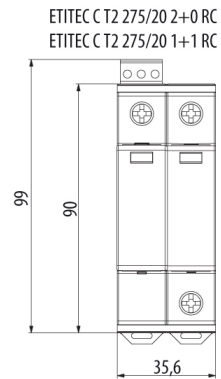
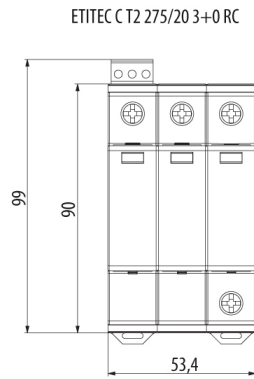
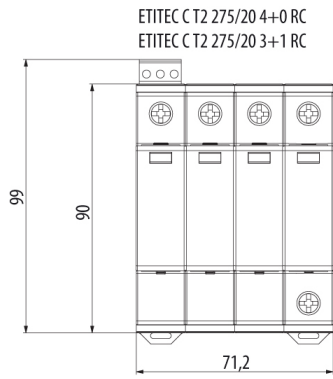

Symbol/Connection

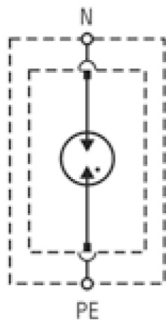

ETITEC CT2 G

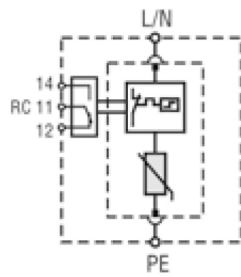

ETITEC CT2 1+0 RC

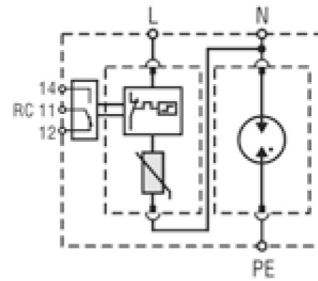

ETITEC CT2 1+1 RC

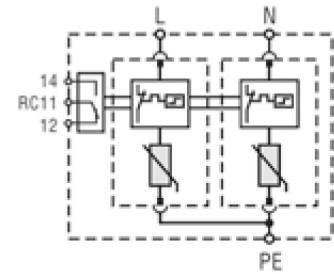

ETITEC CT2 2+0 RC

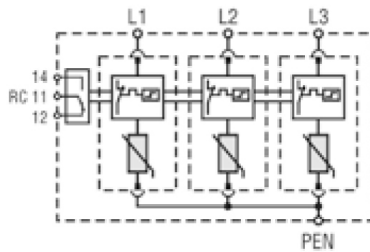

ETITEC CT2 3+0 RC

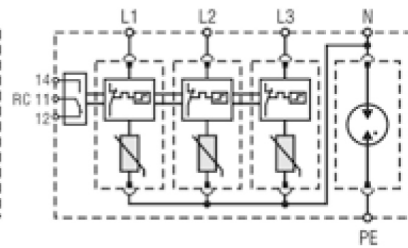

ETITEC CT2 3+1 RC

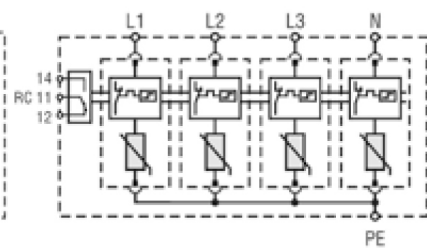

ETITEC CT2 4+0 RC